

Proximity Sensors Inductive Stainless Steel Housing Types IA, M12, M18 and M30, NAMUR

CARLO GAVAZZI

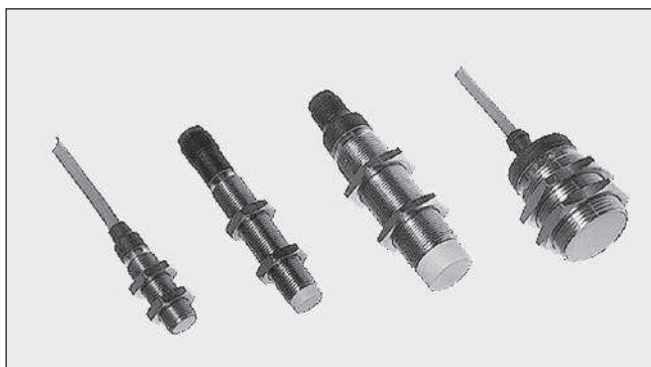

- Stainless steel housing, cylindrical
- Diameter: M12, M18, M30
- Short or long versions
- Sensing distance: 2 to 15 mm
- Output: NAMUR EN 50 227
- Protection: Reverse polarity
- LED-indication
- 2 m cable or plug M12



Product Description

Proximity switch in M12, M18 and M30 stainless steel housing. Made in accordance with Euronorm EN 50 227 and EN

60 947-5-2. For thermoplastic housing refer to type IA 12C.... Amplifier relay SD.... is available.

Ordering Key

IA 12 ESF 02 UC M1

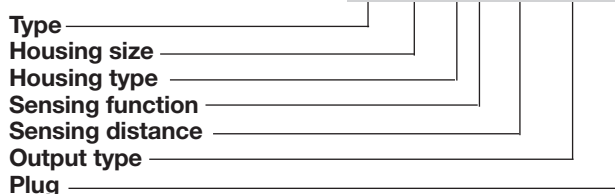

Type Selection

Housing diameter	Body style	Connection	Rated operating distance (S _n)	Ordering no. Namur
M12	Short	Cable	2 mm ¹⁾	IA 12 ESF 02 UC
M12	Short	Plug	2 mm ¹⁾	IA 12 ESF 02 UC M1
M12	Long	Cable	2 mm ¹⁾	IA 12 ELF 02 UC
M12	Long	Plug	2 mm ¹⁾	IA 12 ELF 02 UC M1
M12	Short	Cable	4 mm ²⁾	IA 12 ESN 04 UC
M12	Short	Plug	4 mm ²⁾	IA 12 ESN 04 UC M1
M12	Long	Cable	4 mm ²⁾	IA 12 ELN 04 UC
M12	Long	Plug	4 mm ²⁾	IA 12 ELN 04 UC M1
M18	Short	Cable	5 mm ¹⁾	IA 18 ESF 05 UC
M18	Short	Plug	5 mm ¹⁾	IA 18 ESF 05 UC M1
M18	Long	Cable	5 mm ¹⁾	IA 18 ELF 05 UC
M18	Long	Plug	5 mm ¹⁾	IA 18 ELF 05 UC M1
M18	Short	Cable	8 mm ²⁾	IA 18 ESN 08 UC
M18	Short	Plug	8 mm ²⁾	IA 18 ESN 08 UC M1
M18	Long	Cable	8 mm ²⁾	IA 18 ELN 08 UC
M18	Long	Plug	8 mm ²⁾	IA 18 ELN 08 UC M1
M30	Short	Cable	10 mm ¹⁾	IA 30 ESF 10 UC
M30	Short	Plug	10 mm ¹⁾	IA 30 ESF 10 UC M1
M30	Long	Cable	10 mm ¹⁾	IA 30 ELF 10 UC
M30	Long	Plug	10 mm ¹⁾	IA 30 ELF 10 UC M1
M30	Short	Cable	15 mm ²⁾	IA 30 ESN 15 UC
M30	Short	Plug	15 mm ²⁾	IA 30 ESN 15 UC M1
M30	Long	Cable	15 mm ²⁾	IA 30 ELN 15 UC
M30	Long	Plug	15 mm ²⁾	IA 30 ELN 15 UC M1

¹⁾ For flush mounting in metal

²⁾ For non-flush mounting in metal



Specifications

Rated operational volt. (U_e) (U_B)	8.2 VDC 7 to 9 VDC (6 to 35 VDC, all specifications not observed in extended supply range)	Hysteresis (H) (Differential travel)	1 to 15% of sensing distance
Self-inductance	$\leq 500\mu\text{H}$	Effective operating dist. (S_r)	$0.9 \times S_n \leq S_r \leq 1.1 \times S_n$
Self-capacitance	$\leq 120 \text{ nF}$	Usable operating dist. (S)	$0.9 \times S_r \leq S_u \leq 1.1 \times S_r$
No-load supply current (I_0)	Activated: $\leq 1 \text{ mA}$ Not activated: $\geq 2.2 \text{ mA}$ Max. 9.35 mA	Ambient temperature	Operating Storage
Protection	Reverse polarity	Degree of protection	IP 67 (Nema 1, 3, 4, 6, 13)
Transient voltage	$\leq 1 \text{ kV}/0.5 \text{ J}$	Housing material	Body Front Back
EMC	Approved according to EN 50 080, EN 50 081		Stainless Steel (1.4301) Grey thermoplastic polyester Black thermoplastic polyester
Power ON delay	$< 10 \text{ ms}$	Connection	
Frequency of operating cycles (f)	IA12xxF02 1.400 Hz IA12xxN04 1.200 Hz IA18xxF05 500 Hz IA18xxN08 200 Hz IA30xxF10 300 Hz IA30xxF15 100 Hz	Cable	2 m, 2 x 0.5 mm ² , grey PVC, oil proof M12 x 1
Indication not activated	LED, yellow	Plug	CONH1A series
Assured operating dist. (S_a)	$0 \leq S_a \leq 0.81 S_n$	Cables for plug (-1)	
Repeat accuracy (R)	$\leq 5\%$	Weight (cable excluded)	IA 12xx 20 g IA 18xxF05 26 g IA 18xxN08 30 g IA 30xxF10 75 g IA 30xxN15 80 g
		Tightening torque	IA 12 7.5 Nm IA 18 27.5 Nm IA 30 100 Nm
		Approvals	UL
		CE-marking	Yes

Dimensions

Type	A	B Ø mm	C mm	D mm	E mm	F mm	SW mm
IA 12 ESF 02 UC	M12 x 1 x 30	10.7	30	11	5.0	4	17
IA 12 ELF 02 UC	M12 x 1 x 50	10.7	50	11	5.0	4	17
IA 12 ESF 02 UC M1	M12 x 1 x 30	10.7	30	12.6	11.9	4	17
IA 12 ELF 02 UC M1	M12 x 1 x 50	10.7	50	12.6	11.9	4	17
IA 12 ESN 04 UC	M12 x 1 x 30	10.7	34	11	5.0	4	17
IA 12 ELN 04 UC	M12 x 1 x 50	10.7	54	11	5.0	4	17
IA 12 ESN 04 UC M1	M12 x 1 x 30	10.7	34	12.6	11.9	4	17
IA 12 ELN 04 UC M1	M12 x 1 x 50	10.7	54	12.6	11.9	4	17
IA 18 ESF 05 UC	M18 x 1 x 30	16.7	30	11.6	15.4	4	24
IA 18 ELF 05 UC	M18 x 1 x 50	16.7	50	11.6	15.4	4	24
IA 18 ESF 05 UC M1	M18 x 1 x 30	16.7	30	13.1	11.9	4	24
IA 18 ELF 05 UC M1	M18 x 1 x 50	16.7	50	13.1	11.9	4	24
IA 18 ESN 08 UC	M18 x 1 x 30	16.7	38	11.6	15.4	4	24
IA 18 ELN 08 UC	M18 x 1 x 50	16.7	58	11.6	15.4	4	24
IA 18 ESN 08 UC M1	M18 x 1 x 30	16.7	38	13.1	11.9	4	24
IA 18 ELN 08 UC M1	M18 x 1 x 50	16.7	58	13.1	11.9	4	24
IA 30 ESF 10 UC	M30 x 1.5 x 30	28	30	13.6	15.4	5	36
IA 30 ELF 10 UC	M30 x 1.5 x 50	28	50	13.6	15.4	5	36
IA 30 ESF 10 UC M1	M30 x 1.5 x 30	28	30	13.6	11.9	5	36
IA 30 ELF 10 UC M1	M30 x 1.5 x 50	28	50	13.6	11.9	5	36
IA 30 ESN 15 UC	M30 x 1.5 x 30	28	42	13.6	15.4	5	36
IA 30 ELN 15 UC	M30 x 1.5 x 50	28	62	13.6	15.4	5	36
IA 30 ESN 15 UC M1	M30 x 1.5 x 30	28	42	13.6	11.9	5	36
IA 30 ELN 15 UC M1	M30 x 1.5 x 50	28	62	13.6	11.9	5	36

Dimensions (cont.)

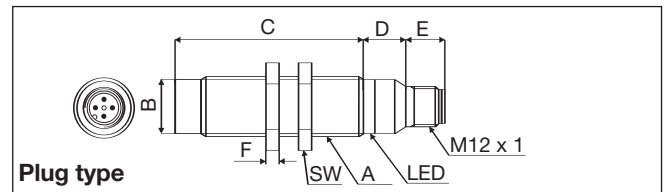
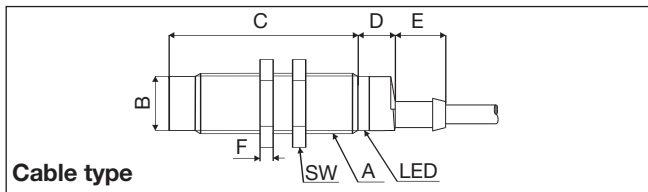

Installation Hints

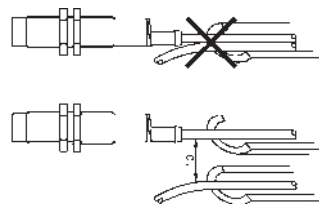
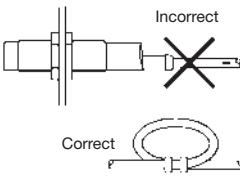
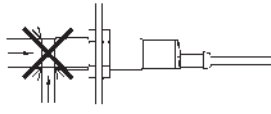
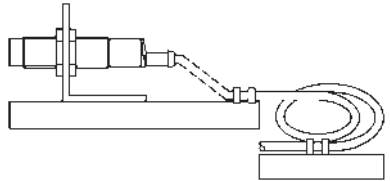
<p><i>To avoid interference from inductive voltage/current peaks, separate the prox. switch power cables from any other power cables, e.g. motor, contactor or solenoid cables</i></p> 	<p><i>Relief of cable strain</i></p>  <p>Incorrect</p> <p>Correct</p> <p>The cable should not be pulled</p>	<p><i>Protection of the sensing face</i></p>  <p>A proximity switch should not serve as mechanical stop</p>	<p><i>Switch mounted on mobile carrier</i></p>  <p>Any repetitive flexing of the cable should be avoided</p>
--	--	---	---

Wiring Diagram

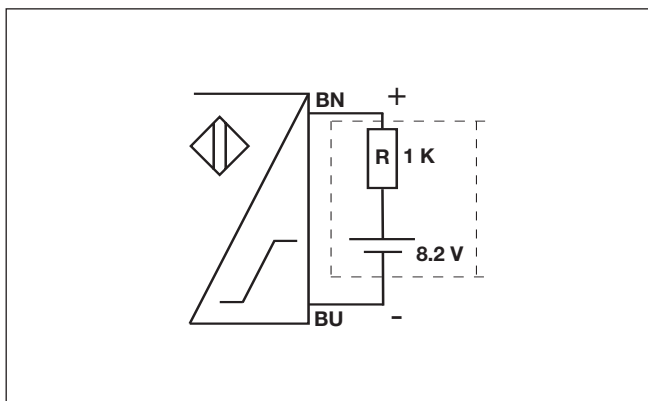

Power Supplies

> SD 110/210 Refer to Technical information.
 > SD 170/270